

EXTERIOR

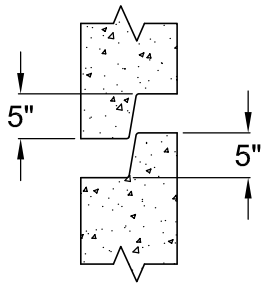

JOINT DETAIL

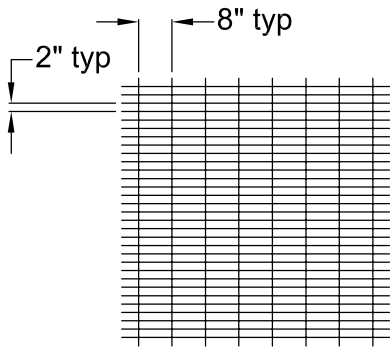

W2.5 x 2.1
Reinforcement
to be area .27
(double cage)
middle of wall

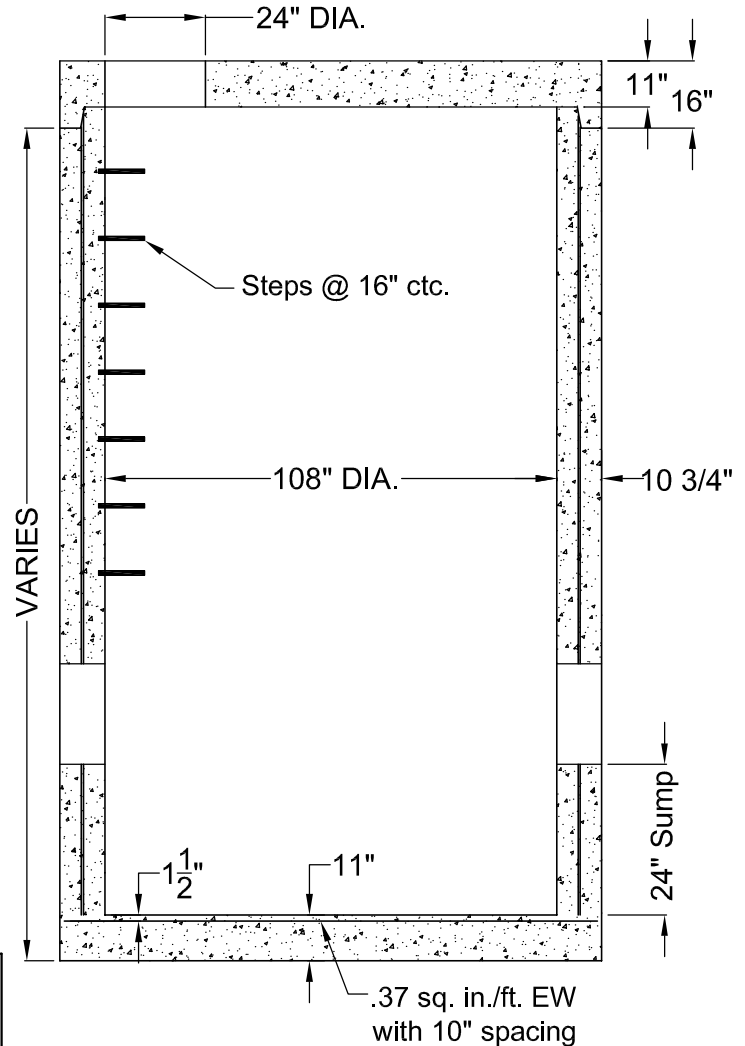
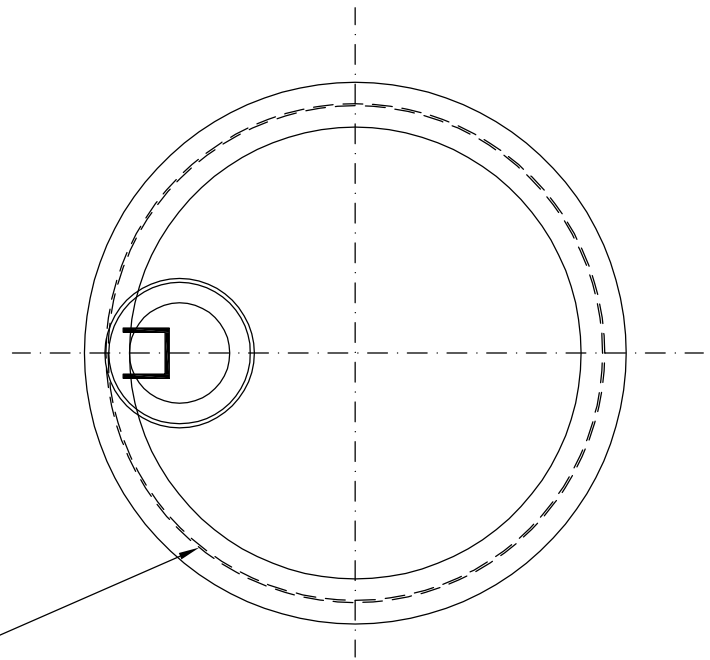

NOTES

1. CONCRETE TO BE MINIMUM 4500 PSI AT 28 DAYS.
2. ALL CONCRETE CATCH BASINS AND MANHOLES ARE MANUFACTURED WITH WELDED STEEL WIRE FABRIC CONFORMING TO ASTM A-185.
3. ALL STRUCTURES ARE MANUFACTURED TO COMPLY WITH ASTM DESIGNATION C-478 AND ILLINOIS DEPARTMENT OF TRANSPORTATION HIGHWAY STANDARDS.

108" DIA. CATCH BASIN



1375 Gifford Rd
Elgin, IL 60120
PH (847) 608-1200
FX (847) 608-1205

DRN BY: AN	DATE 03/06/17	DWG NO.	REV
CHK'D BY:	DATE	SCALE NTS	SHEET OF